



International Conference on Technologies and Materials for Renewable Energy, Environment and Sustainability, TMREES15

## Improving of the Generation Method of Repeated PWM Based on the Signals Combinations Applied to a PV Pumping system

Abdelâali Boumâaraf<sup>a\*</sup>, Tayeb Mohamadi<sup>b</sup> & Nadhir Messai<sup>c</sup>

<sup>a</sup> *Laboratoire des Capteurs, Instrumentations et Procédés (LCIP), University of Abbas LAGHROUR, Khenchela, 40000, Algeria*

<sup>a,b</sup> *University of Farhat ABBAS SETIF<sub>1</sub>, SÉTIF, 19000, Algeria*

<sup>c</sup> *CRESTIC, Université de Reims Champagne-Ardenne, UFR Sciences Exactes et Naturelles, Moulin de la Housse BP 1039, 51687 Reims cedex 2 France*

---

### Abstract

In this paper, we present a new method of the PWM signal generation with repetition of data segments, based on the round robin segment of different amplitudes converters, applied to the photovoltaic water pumping system and the variable frequency variable voltage systems, in order to use the data stored signals to generate other signal amplitudes intermediate to optimize memory usage and reduce the cost of the control board.

© 2015 The Authors. Published by Elsevier Ltd. This is an open access article under the CC BY-NC-ND license (<http://creativecommons.org/licenses/by-nc-nd/4.0/>).

Peer-review under responsibility of the Euro-Mediterranean Institute for Sustainable Development (EUMISD)

*Keywords: PWM, variable frequency variable voltage, Repeated Pulse Width Modulation, photovoltaic.*

---

### 1. Introduction

The technique of Voltage/Frequency (V/F) controlled motors falls under the category of Variable Voltage Variable Frequency (VVVF) drives. To maintain maximum torque for a given working condition, the flux in the machine must be maintained constant. In other words, the ratio of Voltage to frequency must be held constant. For Variable Voltage Variable Frequency (VVVF) drives, there is a need to control the fundamental voltage of the inverter if its frequency (and therefore the frequency of the induction motor), need to be varied. To vary the

---

\* Corresponding author. Tel.: +213-668-616-508; fax: +0-000-000-0000 .  
*E-mail address:* [aboumaaraf@yahoo.fr](mailto:aboumaaraf@yahoo.fr)

fundamental component of the inverter, the Modulation Index of the carrier signal has to be changed. The speed at rated supply frequency is normally used as the base speed. At frequencies below the base speed, the supply magnitude needs to be reduced so as to maintain a constant Volt/Hertz [1].

The VVVF Control converter requires a very specific modulation technique. This method has been the subject of intensive and many research and presented a very limitations in the harmonics rejection to higher frequencies with requires specific circuits and a complex procedures calculations [2, 14].

The application of the repetition technique of data segments of a sampled reference signal RPWM (Repeated Pulse Width Modulation) has given several benefits such as increasing the number of switching periods [15, 17], the improvement of the spectrum by the rejection of harmonics to higher frequencies, therefore the range of frequency variation, improving the current wave and provide a highly optimized control or level of memory [18]. In addition, the technique of robin ARPWM (Alternate Repeated Pulse Width Modulation) allows us to reduce the increment step and improve the loss factor. The application of the art of variable repeated segments can manage and control the pace of change in the frequency of generation of the control signal, decrease the modulation frequency, lower switching losses and increase the loss factor.

The application of these techniques requires a huge memory space especially in the case of high accuracy with no variation. So, to solve this problem we propose a new generation technique uses the data stored reference signals to generate an intermediate signal amplitude. This technique consists of applying a round robin data from the two reference signals.

## 2. Principle of the repeated PWM

The command signal reference is obtained by sampling the sinusoidal signal. The sampled signal will be therefore constituted of equal length segments. Each segment will be converted in an impulse duty cycle that determines the instantaneous amplitude. Each impulse is converted in a numeric shape of n bits to represent the closing and opening state of switches related to the three phase power bridge ( $t_{on}$ ,  $t_{off}$ ) [15,17]. In Fig. 1 we present the duty cycle percentage of each segment and the command signal wave.

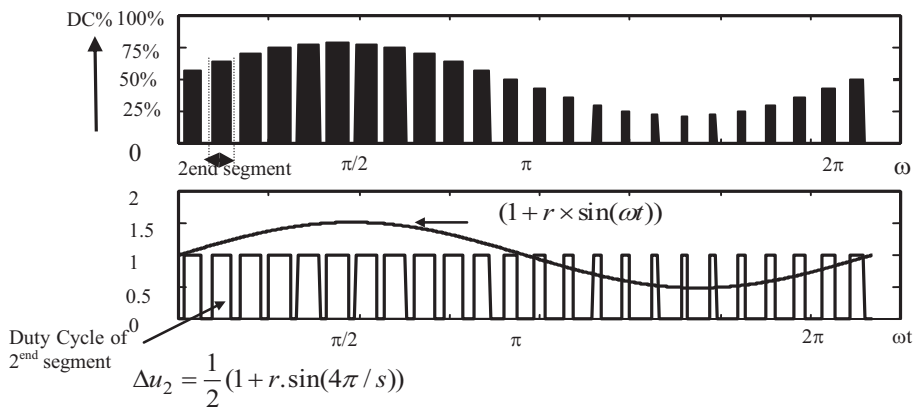

Fig. 1 : Principle of the used PWM control.

The phase tension in the middle point of the bridge (Fig. 2) is given by:

$$Vu = Vdc \cdot \Delta u_i \tag{1}$$

with:

$$\Delta u_i = (1 + r \cdot \sin(i \cdot \frac{2\pi}{s})) / 2, \quad 0 \leq r \leq 1 \tag{2}$$

$$\Delta u = t_{on} / T_s \tag{3}$$

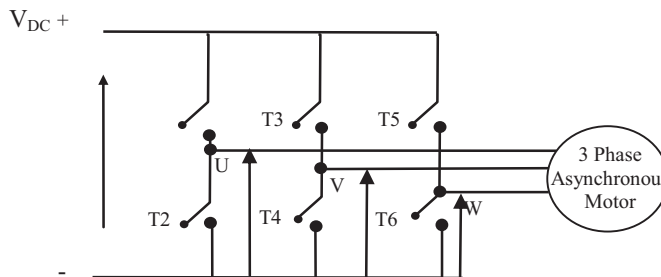

Fig. 2 : The diagram of the converter power unit

### 3. Principle of Signal Frequency Variation

To produce a signal of low frequency (relatively to the frequency of the reference signal), we produce a sequence of repetitions of each n time segment [16,17]. The number of repetition is calculated in such a way to get the frequency required by the system for maintained V/F constant. The Fig. 3 presents, in percentage of the cyclic ratio, command waves where each segment is repeated 2 times, and 3 times.

The frequency change is obtained by the variation of the modulation signal frequency. The frequency of the command signal is calculated by the following formula:

$$F = \frac{f}{B.S.R} \tag{4}$$

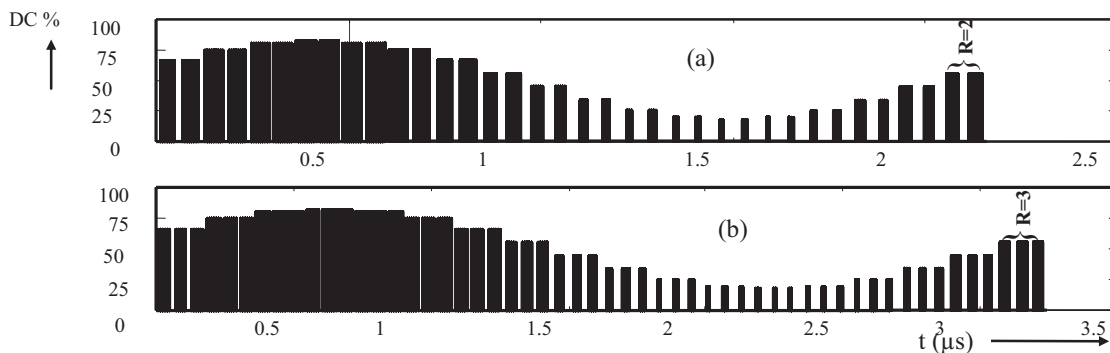

Fig. 3: The signal command wave with repetition  
(a) Two repetitions (b) Tree repetitions

#### 3.1. Alternate repetition (ARPWM)

The problem found in the simple repetition technique (RPWM) is the step frequency variation of the command signal that becomes important in the interval of 50 Hz (Example we cannot generate a frequency between 48.23 Hz and 50.08 Hz [17]). To increase the frequency of data generation witch increases the frequency of modulation and

losses by commutations, or to decrease the number of data of segments (Equation n° 4), is regulated by a generation of signals based on the alternated repetition of data segment, i.e. to repeat segments of the PWM signal alternately; with two different values (for the even and odd segments) as Fig. 4 shows.

### 3.2. Variable Repetition

In this technique each segment “i” is repeated with a different value  $R_i$  of other segments in order to improve the pace of change in frequency and accuracy in the generation of signals [17].

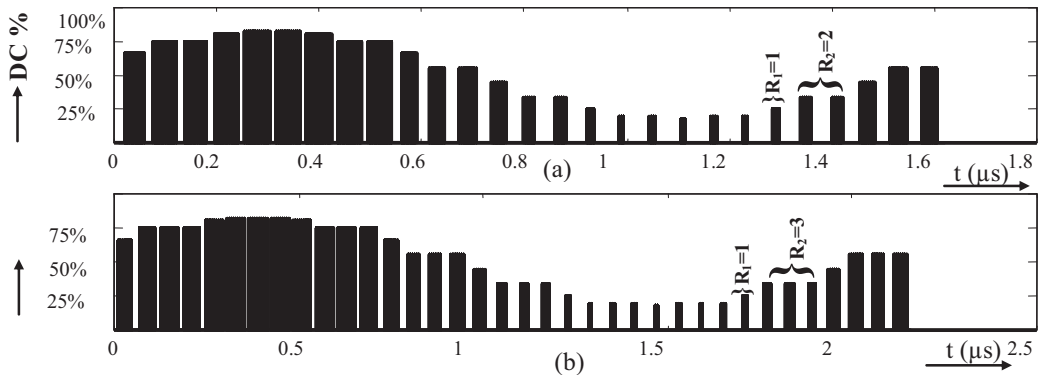

Fig. 4: The command signal with alternate repetition (a) ( $R_1=1, R_2=2$ ) (b) ( $R_1=1, R_2=3$ )

#### 3.2.1. Principle of variable amplitude repetition

The principle for generating control signals of variable amplitude repetition is based on the generation of alternating odd and even segments of the two references control signals obtained by sampling two signals of different amplitudes as shown in Fig. 5.

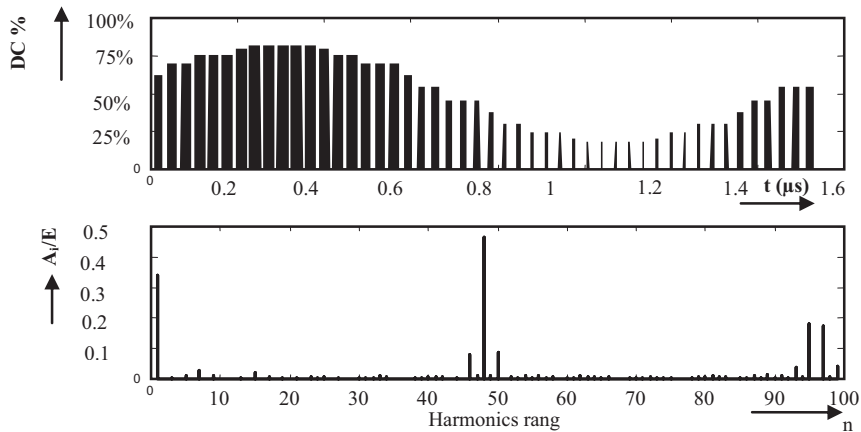

Fig. 5 : Shape and Spectrum of a variably repeated PWM control signal ( $R_1=1, R_2=2, R_3=3$ )

## 4. Combination Repeated PWM (CRPWM)

To generate control signals with intermediate amplitude without recourse to additional data is performed an alternate generation data reference signals closest with a variable depth  $r_m$  Fig.6.

4.1. Mathematics study

The Fourier series development of the composite signal can be obtained by the following formula developed from the equation of the technical RPWM [17].

$$\left\{ \begin{aligned}
 a_n &= \frac{E}{n\pi} \left\{ \sum_{i=0}^{m/2-1} \left( \sum_{k=0}^{R_1-1} \cos \left( n \cdot \frac{2\pi}{S.R} (R.(2.i)+k) \right) - \cos \left( n \cdot \left( \frac{2\pi}{S.R} (R.(2.i)+k) + \frac{\pi}{S.R} (1+r_1 \cdot \sin(\frac{2\pi}{S}(2.i))) \right) \right) \right. \right. \\
 &\quad \left. \left. + \sum_{k=0}^{R_2-1} \cos \left( n \cdot \frac{2\pi}{S.R} (R_1 + R.(2.i)+k) \right) - \cos \left( n \cdot \left( \frac{2\pi}{S.R} (R_1 + R.(2.i)+k) + \frac{\pi}{S.R} (1+r_2 \cdot \sin(\frac{2\pi}{S}(2.i+1))) \right) \right) \right\} \\
 b_n &= \frac{E}{n\pi} \left\{ \sum_{i=0}^{m/2-1} \left( \sum_{k=0}^{R_1-1} \sin \left( n \cdot \frac{2\pi}{S.R} (R.(2.i)+k) \right) - \sin \left( n \cdot \left( \frac{2\pi}{S.R} (R.(2.i)+k) + \frac{\pi}{S.R} (1+r_1 \cdot \sin(\frac{2\pi}{S}(2.i))) \right) \right) \right. \\
 &\quad \left. + \sum_{k=0}^{R_2-1} \sin \left( n \cdot \frac{2\pi}{S.R} (R_1 + R.(2.i+1)+k) \right) - \sin \left( n \cdot \left( \frac{2\pi}{S.R} (R_1 + R.(2.i+1)+k) + \frac{\pi}{S.R} (1+r_2 \cdot \sin(\frac{2\pi}{S}(2.i+1))) \right) \right) \right\}
 \end{aligned} \right. \quad (5)$$

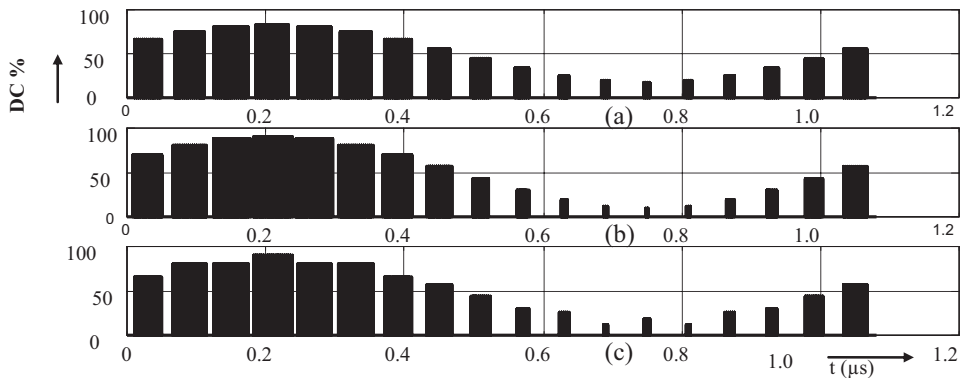

Fig. 6: Example of a control signal (c) obtained from two signals different reference amplitude (a) and (b)

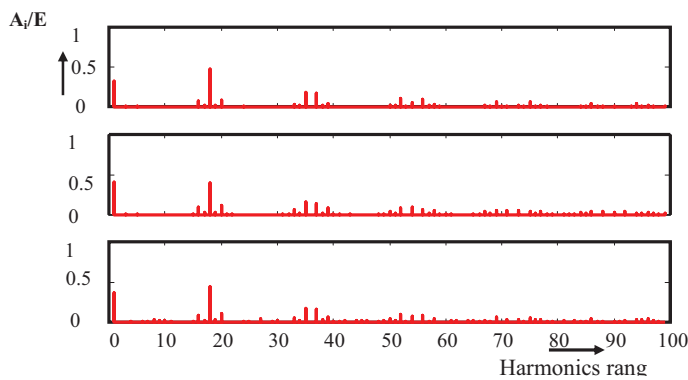

Fig. 7 : Spectrum of the control signals of the Fig. 6

Also, the value of the Asynchronous Motor fundamental depends on the difference in the number of repetitions of the even and odd segments as shown in Fig. 8.

The fundamental value of the composite signal can be calculated according to the right:

$$A_1 = a.R_p + 0,3959.R_i \tag{6}$$

with  $a=0,592$  in the case of  $S=24$ .

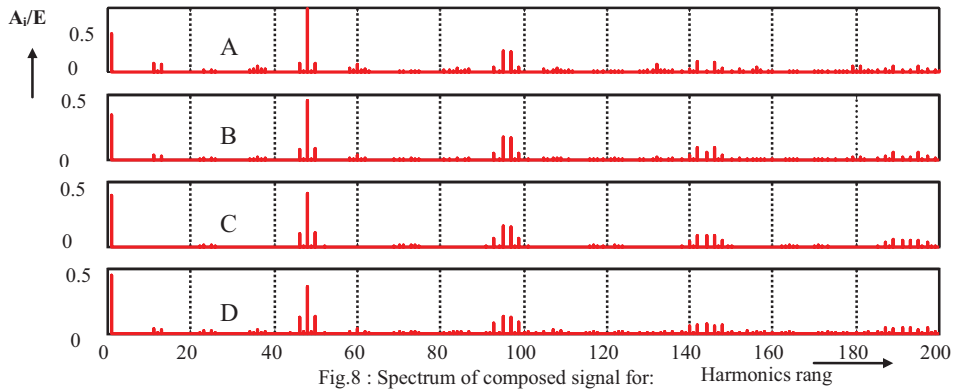

Fig.8 : Spectrum of composed signal for: (A)dr=0.2,(B)dr=0.1,(C)dr=0, (D) dr=-0.1

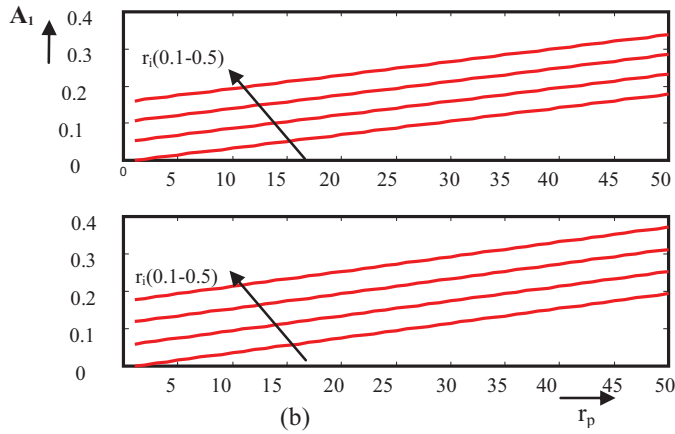

Fig.9 : Value of the amplitude as a function of  $R_p$  and  $R_i$ , with the repetition number (a)  $S=8$  (b)  $S=24$

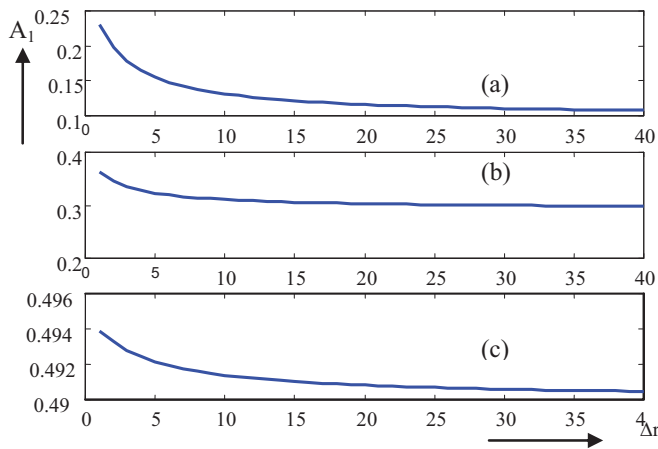

Fig.10 : Amplitude of the fundamental function of the number of repeating segments peer ( $R_p$ ) for three different values of  $\Delta r$  (a)  $r_1=0.5$   $r_2=0.1$  (b)  $r_1=0.5$   $r_2=0.3$  (c)  $r_1=0.5$   $r_2=0.5$

Which the constant 'a' is based on the value of the two signals. It can be calculated as follows:

$$a = \frac{0,05 + 0,05.S}{1 + 0,08.S + 0,0004.S^2} \tag{7}$$

For a case of a reference signal amplitude alternating segments respectful the even and odd value of the fundamental can be calculated from equation 3. Whose coefficient A depends on the ratio  $r_p$  and  $r_i$  as shown in Fig.9 in which A has a function of  $r_p-r_i$ .

To calculate the parameters of the control signals, we must operate compounds according to the following algorithm:

- Select two reference signals already stored;
- Set the frequency to be generated;
- Calculate the parameter 'a' (equation 4);
- Calculate the number of repetitions for each segment (Equation 3).

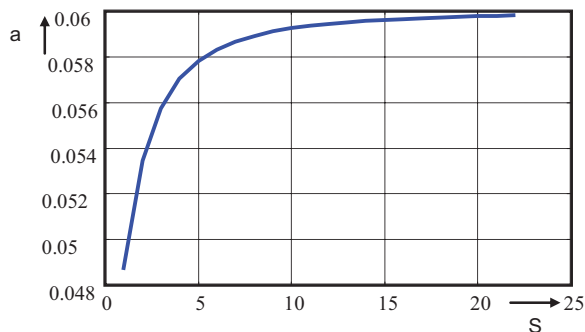

Fig.11 : Value of the 'a' depending on S=2-48.

#### 4.2. Loss factors

The loss factor is one of the main performance indices of the PWM strategy command whose optimal solution is obtained with the minimisation of this quantity. The definition is given as follows:

$$\sigma = \sqrt{\sum_{n=2}^Q \left(\frac{V_n}{n}\right)^2} \tag{8}$$

$Q = 10 \times N$ , N: number of commutations by 1/4 of period [6]. In our case:  $Q = 10 \times S \times R / 4$ .

Notice that the loss factor decreases as the square of amplitude between the two signals associated increases. So to optimize the control we must perform RPWM a choice between loss factor and the value of harmonic published after the application of variable amplitude robin.

#### 5. Electronic command circuit

The electronic command circuit is conceived to proof the theoretical survey and to generate a repeated PWM command signals with combinations method CRPWM. This technique requires a generation of command signals

independently with a very high frequency in the order of 1MHz, to sweep an acceptable field frequency. In this case, the signal generation of the micro-controller becomes unavoidable. Therefore, we opted for a sequential addressing system independently of the micro-controller that can assure the sweep of predefined data, stocked in the EPROM under numeric shape, with autonomous repetition without the intervention of the micro-controller. Which when has measures, tests, numbers and assures the command signals to go from a segment to other with the increments and decrements of depths.

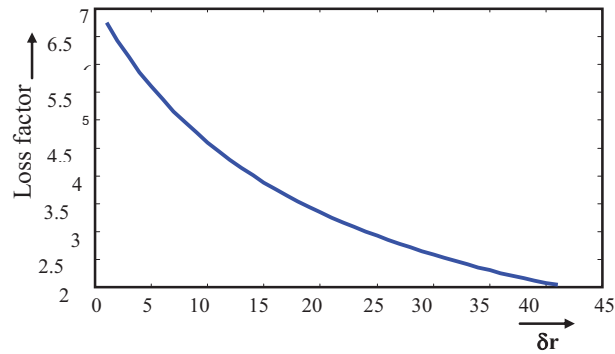

Fig.12 : Loss factor as a function of  $\delta r$ .

This concept has the advantage to assure the generation of short length signals, the reduction of address lines between the micro-controller and the data memory and the reduction of the time allocated by the micro-controller. Therefore a more effective systems (DSP, FPGA,...) for the generation of this command type, is useless.

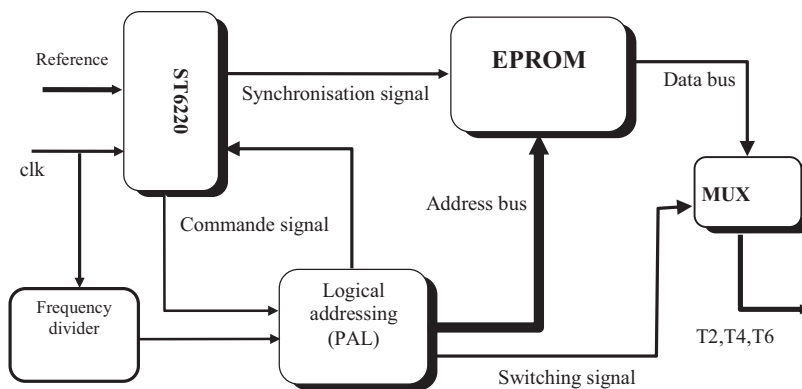

Fig.13 : The diagram of command circuit

### 5.1. Applications of survey results

In table 1, we give some values of frequency that we have calculated and used in tests of converter, as well as the number of repetition for the two segments. We notice that the new suggested technique CRPWM allows us to reach the intermediate frequencies without the change of the modulation frequency that remains 31.26 kHz, with a step of variation decreased to 0.1663 Hz in the interval of 50Hz and 0.0075 Hz in the interval of 10Hz.

Table1. Repetition number and variation frequency of CRPWM method of signal generation

Frequency (Hz)	repetitions Number of odd segments	repetitions Number of even segments	repetitions Number of (R <sub>2</sub> and R <sub>1,a</sub> )	fundamental value of A <sub>r</sub>	fundamental value of A <sub>i</sub>	fundamental value of A	Variation frequency of CRPWM (Hz)	Obs
59,1856	22	22	22	260,4170	249,0940	260,4170	0,223	S.V
58,9623	22	22	23	260,4170	249,0940	259,4340	0,222	N.S.V
58,7406	22	22	24	260,4170	249,0940	258,4590	0,220	N.S.V
58,5206	22	22	25	260,4170	249,0940	257,4910	0,218	N.S.V
58,3022	22	22	26	260,4170	249,0940	256,5300	0,217	N.S.V
58,0855	22	22	27	260,4170	249,0940	255,5760	0,215	N.S.V
57,8704	22	22	28	260,4170	249,0940	254,6300	0,214	N.S.V
57,6568	22	22	29	260,4170	249,0940	253,6900	0,212	N.S.V
57,4449	22	22	30	260,4170	249,0940	252,7580	0,210	N.S.V
57,2344	22	22	31	260,4170	249,0940	251,8310	0,209	N.S.V
57,0255	22	22	32	260,4170	249,0940	250,9120	0,207	N.S.V
56,8182	22	22	33	260,4170	249,0940	250,0000	0,206	N.S.V
56,6123	22	22	34	260,4170	249,0940	249,0940	0,000	N.S.V
56,6123	23	23	23	249,0941	238,7153	249,0941	0,204	S.V
56,4079	23	23	24	248,1948	238,7153	248,1948	0,203	N.S.V
56,2050	23	23	25	247,3020	238,7153	247,3020	0,201	N.S.V
56,0036	23	23	26	246,4158	238,7153	246,4158	0,200	N.S.V
55,8036	23	23	27	245,5358	238,7153	245,5358	0,199	N.S.V
55,6050	23	23	28	244,6620	238,7153	244,6620	0,197	N.S.V
55,4078	23	23	29	243,7943	238,7153	243,7943	0,196	N.S.V
55,2120	23	23	30	242,9329	238,7153	242,9329	0,194	N.S.V
55,0176	23	23	31	242,0775	238,7153	242,0775	0,193	N.S.V
54,8246	23	23	32	241,2281	238,7153	241,2281	0,192	N.S.V
54,6329	23	23	33	240,3846	238,7153	240,3846	0,190	N.S.V
54,4425	23	23	34	239,5470	238,7153	239,5470	0,189	N.S.V
54,2535	23	23	35	238,7153	238,7153	238,7153	0,0017	N.S.V
54,25347	24	24	24	238,7153	238,7153	238,7153		S.V

N.S.V : No Stocked Value . S.V: Stocked Value

## 6. Test And Measures

The test and measurements of the process command achieved as well as the whole converter permitted us to raise very satisfactory results as tensions and the currents of lines (Vu - Vw) as well as their spectres obtained by FLUK 41B, that is represented on the Fig. 13 and Fig. 14, obtained with a motor of 1kw and a tension Vdc=300v for two frequency 22.1 Hz and 49 Hz. The used parameters are a number of segments S=24, the number of bits B=32. We notice that the spectral answer is well very improved relatively to the other application.

## 7. Conclusion

In this work, we presented a survey of the PWM command with a combination signals concretised by an optimised hardware in the choice of components, gain in memory that can reach 100%, the gain in time reserved by the micro-controller that can attain 50% and the sensitivity of the signal generation that is one micro-second. Also, the new technique proposed CRPWM has improved the step of frequency variation especially in the interval of 50Hz which reduced to 0.02 Hz.

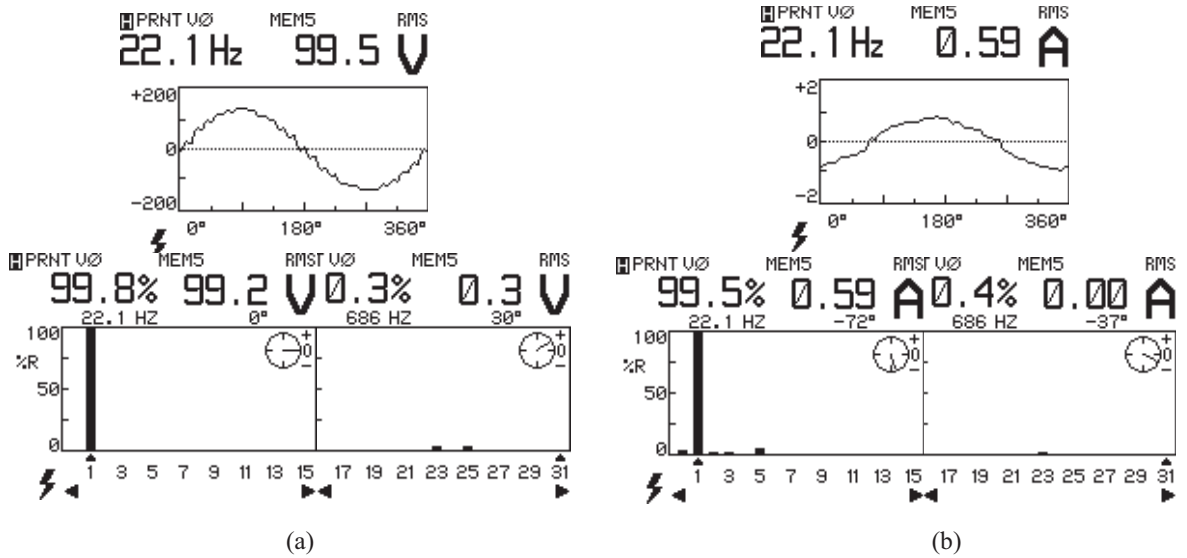

Fig.14 : result obtained by Fluk 41B for f= 22.1 HZ  
 (a) Phase tension and its harmonic content  
 (b) current tension and its harmonic content

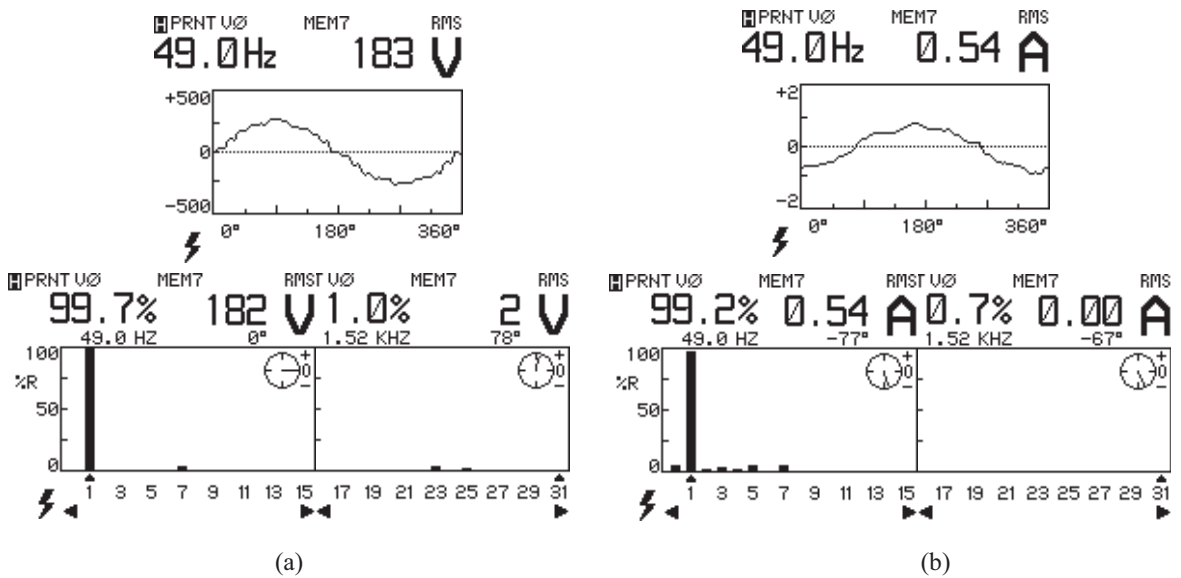

Fig.15. result obtained by Fluk 41B for f= 49.0 HZ  
 (a) Phase tension and its harmonic content  
 (b) current tension and its harmonic content

## Nomenclature

ARPWM	Alternate Repeated Pulse Width Modulation
B	Bits number.
f	Frequency of data generation.
CRPWM	Combination Repeated Pulse Width Modulation
PWM	Pulse Width Modulation
PV	Photovoltaic
r	amplitude of the reference signal
R	Repetitions number.
$R_i$	Number of repeating peers even segments.
$R_p$	Number of repetition of odd segments.
s	Number of segments.
Ts	Time length of a segment (sampling period).
VRPWM	Variable Repeated Pulse Width Modulation
$\Delta u_i$	The duty cycle of the $i^{\text{th}}$ segment of the U phase voltage (% appropriate in opening).
VDC	Phase tension

## References

- [1] Vinay, K.C. ; Shyam, H.N. ; Rishi, S. ; Moorthi, S. FPGA Based Implementation of Variable-Voltage Variable-Frequency Controller for a Three Phase Induction Motor Process Automation. Control and Computing (PACC), 2011 International Conference on Digital Object Identifier: 10.1109/PACC.2011.5978884 Publication Year: 2011 , Page(s): 1 - 6
- [2] Y. Tadors, S. Salama, T. Schütze. Three Level IGBT Inverters for Industrial Drives and Traction Applications. EPE Journal, vol.4 no.2, p.38-42, jun. 1994.
- [3] H. B. Ertan, N. B. Simsir. Comparison of PWM and PFM Induction Drives Regarding Audible Noise and Vibration for Household Applications. IEEE transactions on industry applications, vol. 40, no. 6, p 1621-1628, Nov./Dec. 2004.
- [4] H. Kanaan, K. Al-Haddad, R. Chaffai, L. Duguay, F. Fnaiech, A comparative study of hysteresis and PWM control techniques applied to an injection-current-based three-phase rectifier. CCECE 2001 Conference, Toronto, Ontario, May 14-16, 2001, p 785-792.
- [5] H. L. Liu, G. H. Cho, S. S. Park, Optimal PWM Design High Power Three-Level Inverter Through Comparative Studies. IEEE Tran. On Power Elec., vol.10, no.1, p 38-47, jan.1995.
- [6] R. S. Hamid, A. Toliyat. Vector Control of Five-Phase Synchronous Reluctance Motor with Space Vector Pulse Width Modulation (SVPWM) for Minimum Switching Losses. IEEE International on Industrial Technology, 2008, p 57-63.
- [7] K. K. Tse, H. S.-H. Chung, S. Y. R. Hui, H. C. So. Comparative Study of Carrier-Frequency Modulation Techniques for Conducted EMI Suppression in PWM Converters. IEEE transactions on industrial electronics, vol. 49, no 3, p. 618-627, jun. 2002.
- [8] R. Bojoi, A. Tenconi, F. Profumo, G. Griva, D. Martinello. Complete Analysis and Comparative Study of Digital Modulation Techniques for Dual Three-phase AC Motor. IEEE Power Electronics, p. 851-857, 2002.
- [9] J. N. Chiasson, L. M. Tolbert, K. J. McKenzie, Z. Du. A Complete Solution to the Harmonic Elimination Problem. IEEE transactions on power electronics, vol. 19, no. 2, p 491-499, Mar. 2004.
- [10] D. J. Tooth, N. McNeill, S. J. Finney, B. W. Williams. A New Soft-Switching Technique Using a Modified PWM Scheme Requiring No Extra Hardware. IEEE transactions on power electronics, vol. 16, no. 5, p 686-693, Sep. 2001.
- [11] B.-K. Lee, M. Ehsani. A Simplified Functional Simulation Model for Three-Phase Voltage-Source Inverter Using Switching Function Concept. IEEE transactions on industrial electronics, vol. 48, no. 2, p 309-321, apr. 2001.
- [12] S.-S. Qiu I. M. Filanovsky. Harmonic Analysis of PWM Converters. IEEE transactions on circuits and systems—i: fundamental theory and applications, vol. 47, no. 9, p 1340-1349, sep. 2000.
- [13] S. R. Bowes, S. S. Grewal. Novel Space-Vector-Based Harmonic Elimination Inverter Control. IEEE transactions on industrial applications, vol. 36, no. 2, p 549-557, Mar/Apr 2000.
- [14] P. Piyarungsan, S. Kaitwanidvilai. Harmonic Reduction Technique in PWM AC Voltage Controller using Particle Swarm Optimization and Artificial Neural Network. Proceedings of the International Multi Conference of Engineers and Computer Scientists, 2010, Vol II.
- [15] B. Maurice, JM. Bourgeois, B. Saby. Versatile Cost Effective Induction Motor Drive With Tree Phase Digital Generation. SGS-THOMSON Microelectronics, 1991.
- [16] A. Boumâaraf, M.D. Draou, S. Chikhi. Nouveau concept de la commande PWM destiné au système de pompage photovoltaïque. Revue des énergies renouvelables, vol. 5, no2, p. 139, 2002, [Online]. Available: [www.cder.dz/download/Art5-2\\_6.pdf](http://www.cder.dz/download/Art5-2_6.pdf)
- [17] A. Boumâaraf, T. Mohamadi, M.D. Draou. Optimization of the Repeated PWM Command Applied to the Variable Voltage Variable Frequency (VVVF) Converter. International Journal of Computer Applications, vol. 24, no. 2, p.01-12, Jun. 2011. [Online] Available: <http://www.ijcaonline.org/archives/volume24/number2/2926-3869>